

Laura a její tygři

technické podmínky:

- vjezdová povolení k podiu pro 2 motorová vozidla SPZ 7AV 7928 a SPZ 6Z8 2764
- parkování pro 2 motorová vozidla v blízkosti místa konání akce
- nejméně dva pomocníci na stěhování nástrojové aparatury před a **po vystoupení**
- zastřešené podium o minimálních rozměrech: 8 x 4 m
- přítomnost zvukaře se zapojenou aparaturou
- zvuková aparatura s dostatečnou výkonovou rezervou
- čtyři nezávislé monitorové cesty: A, B, C, D
- přítomnost osvětlovače a základní nasvícení podia
- zabezpečená šatna s vodou a zrcadlem k dispozici 60 minut před a po vystoupení

obsazení kapely:

Kamil Janský	Tenor Sax, Baritone Sax, Vocal (Mic Vocal 1)
Radek Němec	Trumpet, Vocal (Mic Vocal 2)
Milan Král	Trombone, Vocal (Mic Vocal 2)
Lucie Bakešová	Lead Vocal (Mic Lead Vocal)
Karel Šůcha	Bass, Vocal (Mic Vocal 3)
Ondřej Fišer	Guitar, Vocal (Mic Vocal 3)
Tomislav Zvardoň	Guitar
Mirek Návrat	Drums

input list:

	INSTRUMENT	MIC / LINE	Monitor
1	Kick	MIC	
2	Snare Top	MIC	
3	Snare Bott	MIC	
4	Hi-hat	MIC	
5	Overhead - L	MIC	
6	Overhead - R	MIC	
7	Rack Tom 12	MIC	
8	Floor Tom 14	MIC	
9	Floor Tom 16	MIC	
10	Bass	LINE – XLR	
11	Guitar L	MIC Shure SM57	
12	Guitar R	MIC Shure SM57	
13	Trombone	LINE – XLR (vlastní mic a vysílačka)	→ A C D
14	Trumpet	LINE – XLR (vlastní mic a kabel)	→ A C D
15	Tenor Sax	LINE – XLR (vlastní mic a vysílačka)	→ A C D
16	Bariton Sax	MIC Shure SM57	→ A C D
17	Vocal 1	MIC	→ A C
18	Vocal 2	MIC	→ A C
19	Lead Vocal	MIC	→ A B C D
20	Voca 3	MIC	→ A C

Karel Šůcha + 420 725 555 752

LAURA A JEJÍ TYGŘI

STAGE PLÁN

MONITOR D

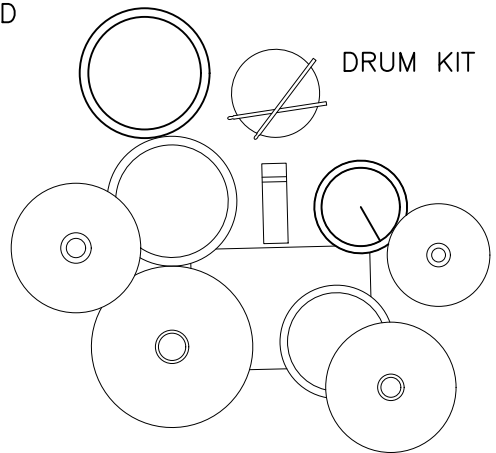
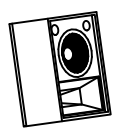

DRUM KIT

BASS AMP

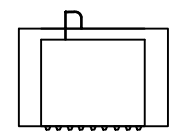

GUITAR AMP L

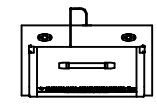

GUITAR AMP R

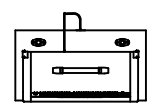

SAXOPHONE



TRUMPET



TROMBONE



BASS

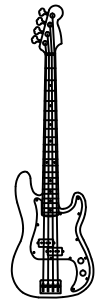

GUITAR

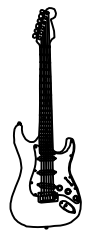

GUITAR

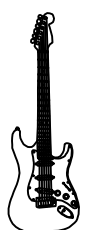

BARITONE SAX

MIC VOCAL 1

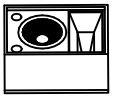

MONITOR A

MIC VOCAL 2

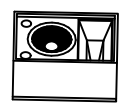

MONITOR A

MIC LEAD VOCAL

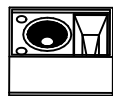

MONITOR B

MIC VOCAL 3

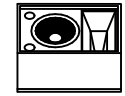

MONITOR C